

Medication Guide
PEGASYS® (PEG-ah-sis)
(peginterferon alfa-2a)
Injection
for Subcutaneous Use

Important: If you are taking PEGASYS with other medicines for treatment of hepatitis C, you should also read the Medication Guides or Patient Information that comes with the other medicines.

What is the most important information I should know about PEGASYS?

Ribavirin in combination with PEGASYS may cause birth defects or death of your unborn baby. If you are pregnant or your sexual partner is pregnant or plans to become pregnant, do not take PEGASYS and Ribavirin combination therapy. You or your sexual partner should not become pregnant during treatment with PEGASYS and Ribavirin combination therapy and for 6 months after treatment is over. You must use 2 effective forms of birth control, one of which should be a condom with spermicide during treatment with PEGASYS and Ribavirin combination therapy, and for the 6 months after you stop treatment.

- Females must have a pregnancy test before starting PEGASYS and Ribavirin combination therapy, every month while being treated, and every month for the 6 months after stopping treatment with PEGASYS and Ribavirin combination therapy.
- **If you or your female sexual partner becomes pregnant during treatment with PEGASYS and Ribavirin or within 6 months after you stop taking PEGASYS and Ribavirin,** tell your healthcare provider right away. You or your healthcare provider should contact the Ribavirin Pregnancy Registry by calling 1-800-593-2214. The Ribavirin Pregnancy Registry collects information about the health of you and your baby if you take PEGASYS and Ribavirin during pregnancy or if you become pregnant within 6 months after you stop taking PEGASYS and Ribavirin.

Mental health problems and suicide. PEGASYS may cause you to develop mood or behavioral problems, including:

- irritability (getting upset easily)
- depression (feeling low, feeling bad about yourself or feeling hopeless) and anxiety
- aggressive behavior
- former drug addicts may fall back into drug addiction or overdose
- thoughts of hurting yourself or others, or suicide

Heart problems. PEGASYS may cause heart problems, including:

- high blood pressure
- fast heart rate or abnormal heart beat
- chest pain
- heart attacks
- trouble breathing

Stroke or symptoms of a stroke. Symptoms may include weakness, loss of coordination, and numbness. Stroke or symptoms of a stroke may happen in people who have some risk factors or no known risk factors for a stroke.

New or worsening autoimmune problems. Some people taking PEGASYS develop autoimmune problems (a condition where the body's immune cells attack other cells or organs in the body), such as rheumatoid arthritis, systemic lupus erythematosus, and psoriasis. In some people who already have an autoimmune problem, it may get worse during your treatment with PEGASYS.

Infections. Symptoms may include:

- fever
- chills
- burning and painful urination
- urinating often
- coughing up yellow or pink mucus (phlegm)

Call your healthcare provider right away if you get any of these symptoms during treatment with PEGASYS:

Before and during treatment with PEGASYS you will need to see your healthcare provider regularly and have blood tests to make sure that your treatment is working and to check for side effects.

PEGASYS can cause serious side effects. Some of these side effects may cause death. Tell your healthcare provider right away if you have any of these symptoms during treatment with PEGASYS.

For more information about side effects, see "What are the possible side effects of PEGASYS?"

What is PEGASYS?

PEGASYS is a prescription medicine that is:

- used with other hepatitis C virus (HCV) antiviral medicines to treat adults who have chronic (lasting a long time) hepatitis C infection and compensated liver disease.
- used alone to treat adults with chronic hepatitis C (CHC) and compensated liver disease, and who are not able to take other HCV antiviral medicines.
- used with Ribavirin to treat children 5 years of age and older who have CHC and compensated liver disease.

PEGASYS should not be used alone or with Ribavirin, without taking other HCV antiviral medicines, to treat people with CHC who have taken interferon-alfa and it did not work.

PEGASYS should not be used to treat people with CHC who have received an organ transplant.

PEGASYS is a prescription medicine that is:

- used alone to treat adults and children 3 years and older with chronic hepatitis B (CHB) virus who show signs that the virus is damaging the liver

It is not known if PEGASYS is safe and effective in:

- children with CHC under 5 years of age or children with CHB under 3 years of age.
- people with Hepatitis B virus (HBV) who also have HCV or HIV infection
- people with HCV who also have HBV, or HIV infection and their CD4+ cell count is less than 100 cells/mm³

Who should not take PEGASYS?

Do not take PEGASYS if you:

- have had a serious allergic reaction to another alpha-interferon medicine or to any of the ingredients in PEGASYS. Symptoms of a serious allergic reaction to alpha-interferon may include itching, swelling of your face, tongue, throat, trouble breathing, feeling dizzy or faint, and chest pain. See the end of this Medication Guide for a list of the ingredients in PEGASYS.
- have certain types of hepatitis caused by your immune system attacking your liver (autoimmune hepatitis)
- have certain other liver problems

Do not give PEGASYS to a baby under 1 year of age. PEGASYS contains benzyl alcohol. Benzyl alcohol can cause nervous system problems and other problems which may lead to death.

Do not take PEGASYS in combination with Ribavirin if you:

- are pregnant, or plan to get pregnant during treatment, or during the 6 months after treatment
- are a male with a female sexual partner who is pregnant or plans to become pregnant at any time during treatment with Ribavirin or during the 6 months after your treatment has ended.

Talk to your healthcare provider before taking PEGASYS if you have any of these conditions.

Before taking PEGASYS tell your healthcare provider about all of your medical conditions, including if you :

- have or ever had any problems with your heart, including heart attack
- have high blood pressure
- have liver problems (other than hepatitis B or C)
- have lung problems
- have thyroid problems
- have diabetes
- have colitis (inflammation of your intestine)
- have any kind of autoimmune disease (where the body's immune system attacks the body's own cells), such as psoriasis, systemic lupus erythematosus, or rheumatoid arthritis
- have or ever had low blood cell counts
- have cancer
- have or had blood disorders (bleeding problems or a blood clot, thalassemia major or sickle-cell anemia)
- hepatitis B or C infection
- have Human Immunodeficiency Virus -1 (HIV-1) infection
- have kidney problems
- have high blood triglyceride levels (fat in your blood)
- have had an organ transplant
- have ever been addicted to drugs or alcohol
- are being treated for a mental illness or had treatment in the past for any mental illness, including depression and

suicidal behavior.

- are pregnant or plan to become pregnant. It is not known if PEGASYS will harm your unborn baby. Tell your healthcare provider if you become pregnant during treatment with PEGASYS.
- are breastfeeding or plan to breastfeed. It is not known if PEGASYS passes into your breast milk. You and your healthcare provider should decide if you will use PEGASYS or breastfeed. You should not do both.
 - If you have HIV-1 infection and are being treated with PEGASYS, you should not breastfeed because of the risk of passing HIV-1 to your baby.

Tell your healthcare provider about all the medicines you take, including prescription and over-the-counter medicines, vitamins and herbal supplements. PEGASYS and certain other medicines may affect each other and cause side effects.

Especially tell your healthcare provider if you take:

- telbivudine (Tyzeka)
- theophylline (Theo-24, Elixophyllin, Uniphyll, Theolair). Your healthcare provider may need to monitor the amount of theophylline in your body and make changes to your theophylline dose.
- any anti-HIV medicines
- methadone hydrochloride (Methadose, Dolophine hydrochloride)
- Keep a list of your medicines and show it to your healthcare provider and pharmacist when you get a new medicine.
- Do not start a new medicine without telling your healthcare provider. Your healthcare provider can tell you if it is safe to take PEGASYS with other medicines.

How should I take PEGASYS?

- PEGASYS is given by injection under the skin (subcutaneous injection).
- Your healthcare provider will decide on your dose of PEGASYS and when you will take it. PEGASYS is usually injected 1 time each week. For children 3 years of age and older infected with hepatitis B virus or 5 years of age and older infected with hepatitis C virus, your healthcare provider will prescribe the dose of PEGASYS based on your child's height and weight.
- If your healthcare provider decides that you can inject PEGASYS for your condition, inject it exactly as prescribed.
- See the Instructions for Use that comes with your PEGASYS for detailed instructions about how to prepare and inject a dose of PEGASYS.
- Your healthcare provider may change your dose of PEGASYS if needed. Do not change your dose unless your healthcare provider tells you to change it.
- Do not switch to another brand of interferon without talking to your healthcare provider.
- Take your prescribed dose of PEGASYS 1 time each week, on the same day of each week and at approximately the same time.
- Do not take more than your prescribed dose.
- **PEGASYS comes as a liquid:**
 - in a single-dose vial
 - in a prefilled syringe
 - in an autoinjectorYour healthcare provider will decide which one is best for you.
- Your healthcare provider should show you how to **prepare and measure, and inject** your dose of PEGASYS before you use the single-dose vial, prefilled syringe or autoinjector for the first time.
 - When you get your prescription from the pharmacy, ask your pharmacist for the syringe and needle that you need to use to prepare and inject a dose of PEGASYS from the single-dose vial.
- If you will be injecting a child with PEGASYS, you will need a special syringe called a tuberculin syringe, which can measure doses of PEGASYS that are 1 milliliter (1mL) or less.
- **Do not reuse** PEGASYS single-dose vials, prefilled syringes, autoinjectors, and needles.
- If you miss your dose:
 - **If you remember within 2 days of when you should have taken PEGASYS, give yourself an injection of PEGASYS as soon as you remember. Take your next dose on the day you would usually take it.**
 - If more than 2 days have passed, ask your healthcare provider what you should do.
- If you take more than the prescribed amount of PEGASYS, call your healthcare provider right away. Your healthcare provider may want to examine you and do blood tests.

What should I avoid while taking PEGASYS?

- Avoid drinking alcohol. This may make your liver disease worse.
- Avoid driving or operating machinery if you become dizzy, confused, very sleepy, or tired during treatment with PEGASYS.

What are the possible side effects of PEGASYS?

PEGASYS can cause serious side effects including:

- See “**What is the most important information I should know about PEGASYS?**”
- **Blood problems.** PEGASYS can affect your bone marrow and cause low red blood cell, low white blood cell and low platelet counts. These blood counts may fall to dangerously low levels. If your blood cell counts become very low, you can get anemia, infections or have problems with bleeding and bruising.
- **Thyroid problems.** Symptoms of thyroid changes include feeling cold or hot all the time, a change in your weight, and changes to your skin, trouble concentrating.
- **Blood sugar problems.** PEGASYS may cause low blood sugar (hypoglycemia), high blood sugar (hyperglycemia) or diabetes. If you have high blood sugar or diabetes before starting PEGASYS, talk to your healthcare provider before you take PEGASYS. If you develop high blood sugar or diabetes during treatment with PEGASYS, your healthcare provider may tell you to stop PEGASYS and prescribe a different medicine for you.
Symptoms of low blood sugar may include:
 - feeling faint
 - headaches,
 - sweating
 - anxiousness
 - confusion
 - weaknessSymptoms of high blood sugar or diabetes may include:
 - increased thirst
 - tiredness
 - urinating more often than normal
 - increased appetite
 - weight loss
 - your breath smells like fruit
- **Serious eye problems.** PEGASYS may cause eye problems that may lead to vision loss or blindness. You should have an eye exam before you start taking PEGASYS. If you have eye problems or have had them in the past, you may need eye exams during treatment with PEGASYS. Tell your healthcare provider or eye doctor right away if you have any vision changes during treatment with PEGASYS.
- **Serious liver problems,** worsening of liver problems including liver failure and death. Symptoms may include:
 - nausea
 - loss of appetite
 - tiredness
 - diarrhea
 - yellowing of your skin or the white part of your eyes
 - bleeding more easily than normal
 - swelling of your stomach area (abdomen)
 - confusion
 - sleepiness
 - you cannot be awakened (coma)
- **Lung problems,** including:
 - trouble breathing
 - pneumonia
 - inflammation of lung tissue
 - new or worse high blood pressure of the lungs (pulmonary hypertension). This can be severe and may lead to death.You may need to have a chest X-ray or other tests if you develop fever, cough, shortness of breath or other symptoms of a lung problem during treatment with PEGASYS.
- **Inflammation of your intestines (colitis).** Symptoms of inflammation of your intestines (colitis) may include:
 - severe stomach area (abdomen) pain
 - fever
 - bloody diarrhea or blood bowel movements
- **Inflammation of your pancreas (pancreatitis).** Symptoms of inflammation of your pancreas (pancreatitis) may include:
 - severe stomach (abdomen) pain
 - severe back pain
 - nausea
 - vomiting
 - fever
- **Serious allergic reactions and skin reactions.** Get medical help right away if you get any of the following symptoms:
 - itching
 - swelling of your face, eyes, lips, tongue, or throat
 - trouble breathing
 - skin rash, hives, sores in your mouth, or your skin blisters and peels
 - chest pain
 - feeling faint
- **Effect on growth in children.** Children can experience a delay in weight gain and height increase during treatment with PEGASYS. In children with hepatitis C, catch-up in growth happens after treatment stops, but some children may not reach the height that they were expected to have before treatment. In children with hepatitis B, it is not yet known if catch-up in growth happens after treatment stops. Talk to your healthcare provider if you are concerned about your child's growth during treatment with PEGASYS.
- **Nerve problems.** People who take PEGASYS or other alfa interferon products with telbivudine (Tyzeka) for hepatitis B can develop nerve problems such as continuing numbness, tingling, or burning sensation in the arms or legs (peripheral neuropathy). Call your healthcare provider if you have any of these symptoms.

Tell your healthcare provider right away if you have any of the symptoms listed above.

The most common side effects of PEGASYS include:

- flu-like symptoms. Symptoms may include tiredness, weakness, fever, chills, muscle aches, joint pain, and headaches. Some of these symptoms may be decreased by injecting your PEGASYS dose in the evening. Talk to your healthcare provider about which over-the-counter medicines you can take to help prevent or decrease some of the symptoms.

Tell your healthcare provider if you have any side effect that bothers you or that does not go away.

These are not all of the side effects of PEGASYS.

Call your doctor for medical advice about side effects. You may report side effects to FDA at 1-800-FDA-1088.

You may also report side effects to Genentech at 1-888-835-2555.

How should I store PEGASYS?

- Store PEGASYS single-dose vials, prefilled syringes, and autoinjectors in a refrigerator at 36°F to 46°F (2°C to 8°C).
- **Do not** leave PEGASYS out of the refrigerator for more than 24 hours.
- **Do not** freeze or shake PEGASYS.
- Protect PEGASYS from light.

Keep PEGASYS and all medicines out of the reach of children.

General information about the safe and effective use of PEGASYS.

Medicines are sometimes prescribed for purposes other than those listed in a Medication Guide. Do not use PEGASYS for a condition for which it was not prescribed. Do not give PEGASYS to other people, even if they have the same symptoms that you have. It may harm them. You can ask your healthcare provider or pharmacist for information that is written for health professionals.

What are the ingredients in PEGASYS?

Active ingredient: interferon alfa-2a

Inactive ingredients: acetic acid, benzyl alcohol, polysorbate 80, sodium acetate trihydrate, and sodium chloride.

Manufactured by: Hoffmann-La Roche, Inc. c/o Genentech, Inc. A Member of the Roche Group

1 DNA Way South San Francisco, CA 94080-4990

U.S. License No. 0136

PEGASYS® is a registered trademark of Hoffmann-La Roche Inc.

This Medication Guide has been approved by the U.S. Food and Drug Administration

Revised: October 2017

Instructions for Use
PEGASYS® (PEG-ah-sis)
(peginterferon alfa-2a)
Injection
For Subcutaneous Use
ProClick™ Autoinjector

First read the Medication Guide that comes with PEGASYS for the most important information you need to know about PEGASYS. Be sure that you read, understand and follow these Instructions for Use before injecting PEGASYS. Your healthcare provider should show you how to prepare and use your PEGASYS ProClick™ autoinjector properly before you use it for the first time. Ask your healthcare provider if you have any questions.

PEGASYS ProClick™ Autoinjectors come either in a box that contains 1 single-dose autoinjector or in a Monthly Convenience Pack that contains 4 single-dose autoinjectors.

Before starting, collect all of the supplies that you will need to inject a dose of PEGASYS. You will need the following supplies:

- 1 PEGASYS ProClick™ single-dose autoinjector
- 1 alcohol pad
- You will also need a puncture-resistant disposable container to throw away your used autoinjector as soon as you finish your injection. See the section “**How should I dispose of the used PEGASYS ProClick Autoinjector?**”

Important information:

- Use your autoinjector exactly as your healthcare provider tells you.
- **Never reuse the same autoinjector.**
- Your healthcare provider should show you or your caregiver how to use your autoinjector correctly before you use it the first time.
- **Do not** try to open the autoinjector or take it apart.
- **Do not** use your autoinjector to inject through clothing covering your skin.
- **Do not** use your autoinjector if it looks damaged.
- **Do not** shake your autoinjector. If shaken, PEGASYS may not work properly.
- **Do not** remove the blue cap until you are ready to inject.
- **Do not** move or handle the red needle-shield before, during or after use. This is a safety device.

PEGASYS ProClick™ Autoinjector parts (see Figure “A”)

Figure “A”

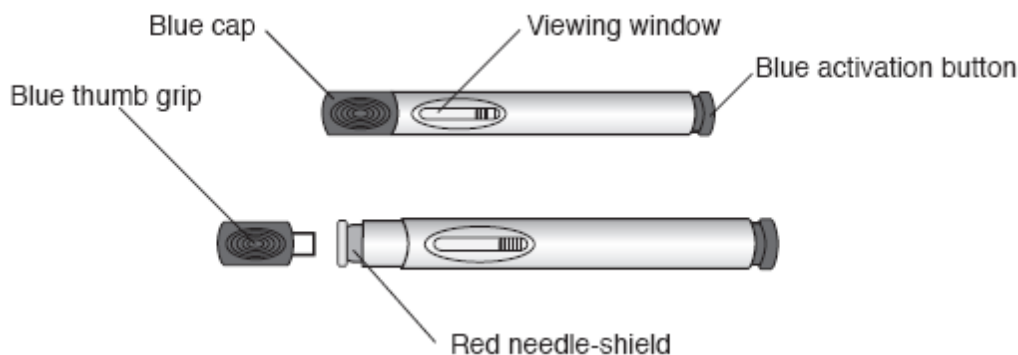

Step 1. Prepare a dose of PEGASYS with your PEGASYS ProClick™ Autoinjector

- Find a well-lit, clean flat surface such as a table.

- **Look at your autoinjector:**

- Take a carton containing your autoinjector out of the refrigerator and take your autoinjector out of the carton. **Keep the blue cap on your autoinjector until Step 3.** Allow the autoinjector to come to room temperature for about 20 minutes to warm up. Do not warm up the autoinjector in any other way.
- **Check** the expiration date on the carton and autoinjector to make sure that it has not passed (expired). Do not use the autoinjector if the expiration date has passed (see **Figure “B”**).

Figure “B”

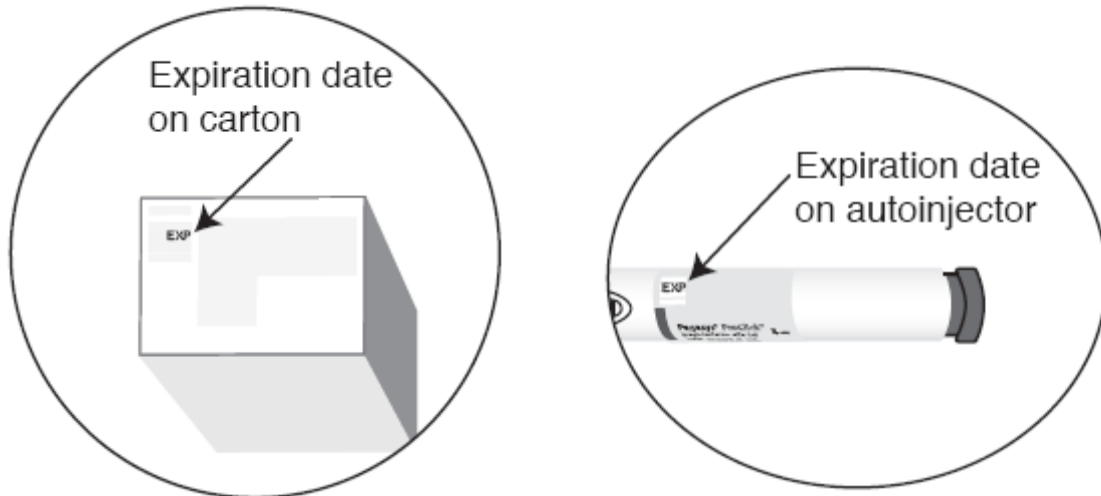

- **Look** at the autoinjector to make sure that it is not damaged in any way. Do not use the autoinjector if it looks damaged.
- Then, **look** at the medicine inside of the autoinjector by looking through the viewing window. The medicine in the autoinjector should be clear and colorless to slightly yellowish.
- **Do not shake** the autoinjector. If there is foam in the medicine, put the autoinjector back in the refrigerator and use it at a later time.
- **Do not use the autoinjector if the medicine in it:**
 - is cloudy
 - contains particles

Use a different autoinjector and contact your healthcare provider or pharmacist, or call Genentech at 1-877-436-3683 for assistance.

- Wash your hands with soap and water.

Step 2. Choose and prepare an injection site

- Choose an injection site on your stomach or thigh (see **Figure “C”**). Avoid the 2 inch area around your belly button (navel) and your waistline. Use a different place each time you give yourself an injection.

Figure “C”

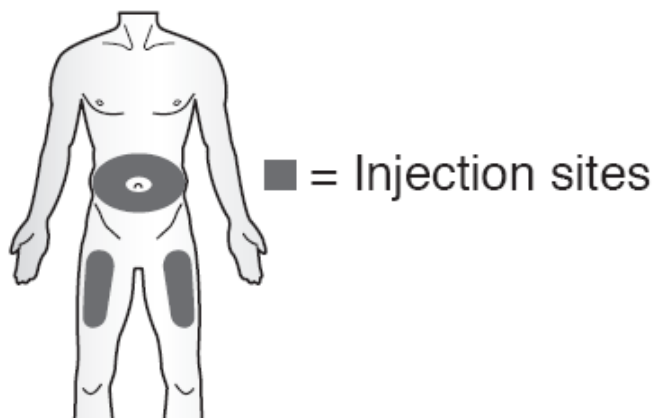

- Clean the injection site using the alcohol pad (see **Figure “D”**). Let the skin dry for 10 seconds. Be sure not to touch the cleaned area before injecting.

Figure “D”

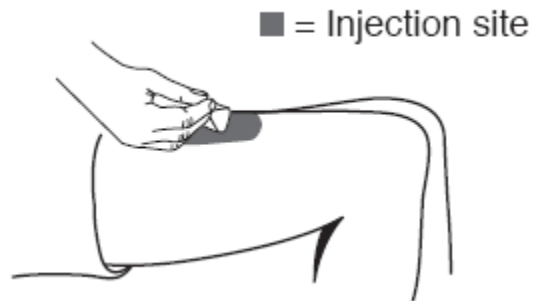

Step 3. Remove blue cap from autoinjector

- Hold the autoinjector firmly with one hand and pull off the blue cap with the other hand (see **Figure “E”**).

After the blue cap is removed, set it aside. The blue cap contains a loose-fitting metal tube. **Never reattach the blue cap after it has been removed.**

Figure “E”



Step 4. Injecting PEGASYS

- Hold the autoinjector comfortably in your hand. Pinch and hold a fold of skin at the injection site with your other hand, so that the red needle-shield can rest on the skin-fold firmly and safely (see **Figure “F”**).

Figure "F"

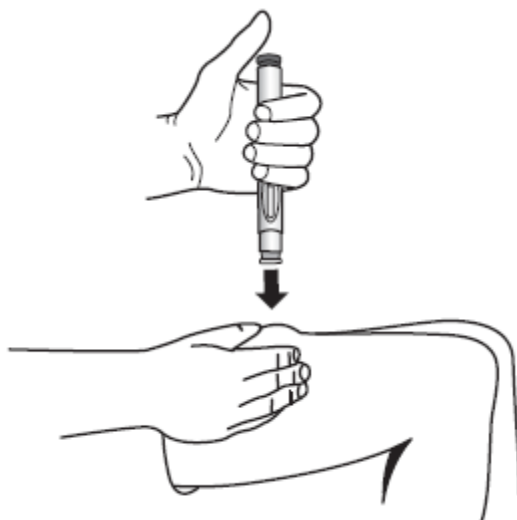

Place the autoinjector straight up and down on your skin at a right angle (90°) on the injection site (see **Figure "G"**).

- **Do not press the blue activation button yet.** Press the autoinjector firmly against your skin until the red needle-shield is completely pushed in (see **Figure "G"**). The autoinjector is now unlocked and ready for injection.

Figure "G"

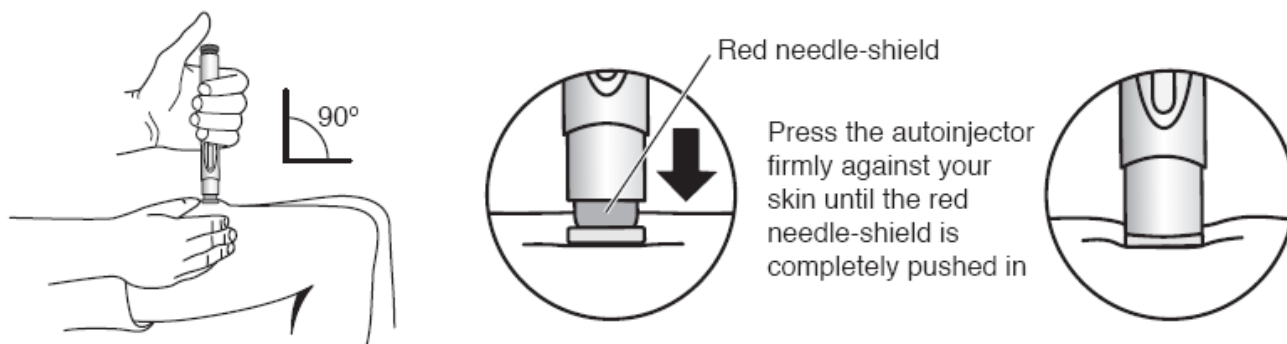

- While holding the autoinjector firmly in place, press the blue activation button with your thumb and **release the blue button right away** (see **Figure "H"**). **Make sure to take your thumb off the blue activation button and do not press it again.**
 - You should hear a "click" sound, telling you that the injection has started.
 - The red indicator should move down in the viewing window during the injection (see **Figure "I"**).

Figure "H"

Figure "I"



Continue to hold the autoinjector pressed firmly against your skin. **Slowly count to 10 to be sure that your injection is complete** (see **Figure “J”**).

- You may hear a second click as the blue activation button pops back up.
- The viewing window should now be completely red.

Figure “J”

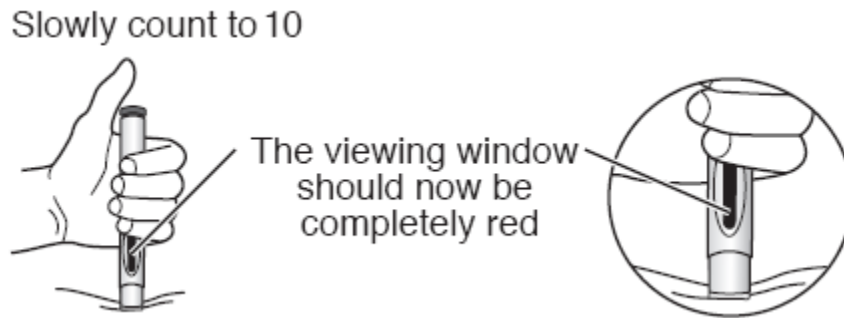

- After you slowly count to 10, lift the autoinjector straight up (90° angle) from your skin. The red needle-shield will automatically move out and lock to prevent needle stick injuries (see **Figure “K”**).

Figure “K”

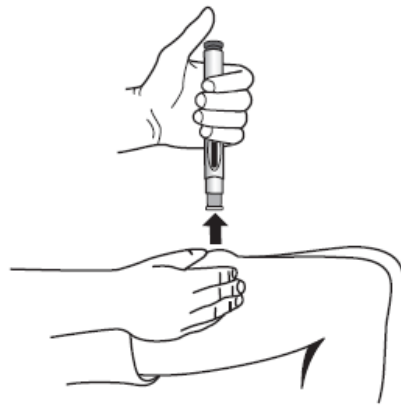

If the viewing window is not completely filled by the red indicator,

- the red needle-shield may not have locked.
 - Do not touch the tip of the autoinjector, because a needle-stick injury may happen.
- you may not have received your full dose of PEGASYS.
 - **Do not** try to reuse the autoinjector
 - **Do not** repeat the injection with another autoinjector
 - **Call your healthcare provider for instructions**

If you see leakage around the injection site, you may not have received your full dose of PEGASYS.

- **Do not** try to reuse the autoinjector
- **Do not** repeat the injection with another autoinjector
- **Call your healthcare provider for instructions**

Step 5. After the injection:

- **Do not try to re-cap your autoinjector.**
- Throw away your used autoinjector and blue cap right away as described below in the section **“How should I dispose of the used PEGASYS ProClick™ Autoinjector?”** (see **Figure “L”**).

Figure “L”



Wipe the injection site with the alcohol pad (see **Figure “M”**).

Figure “M”

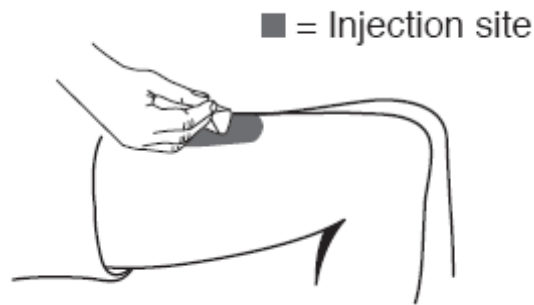

- **Wash your hands with soap and water.**

How should I dispose of the used PEGASYS ProClick™ Autoinjector?

- Put your used needles and syringes in a FDA-cleared sharps disposal container right away after use. **Do not throw away (dispose of) loose needles and syringes in your household trash.**
- If you do not have a FDA-cleared sharps disposal container, you may use a household container that is:
 - made of a heavy-duty plastic,
 - can be closed with a tight-fitting, puncture-resistant lid, without sharps being able to come out,
 - upright and stable during use,
 - leak-resistant, and
 - properly labeled to warn of hazardous waste inside the container.
- When your sharps disposal container is almost full, you will need to follow your community guidelines for the right way to dispose of your sharps disposal container. There may be state or local laws about how you should throw away used needles and syringes. For more information about safe sharps disposal, and for specific information about sharps disposal in the state that you live in, go to the FDA’s website at: <http://www.fda.gov/safesharpsdisposal>.
- Do not dispose of your used sharps disposal container in your household trash unless your community guidelines permit this. Do not recycle your used sharps disposal container.

Always keep the puncture-resistant container out of the reach of children.

How should I store the PEGASYS ProClick™ Autoinjector?

- Store PEGASYS in the refrigerator between 36°F to 46°F (2°C to 8°C).
- **Do not** leave PEGASYS out of the refrigerator for more than 24 hours.
- **Do not** freeze or shake PEGASYS.

- Protect PEGASYS from light.

Keep PEGASYS and all medicines out of the reach of children.

If you have any concerns or questions about your autoinjector, contact your healthcare provider or pharmacist, or call Genentech at 1-877-436-3683 for assistance.

This Instructions for Use has been approved by the U.S. Food and Drug Administration.

Revised: October 2017

PEGASYS® is a registered trademark of Hoffmann-La Roche Inc.

Manufactured by:

Hoffmann-La Roche, Inc.

c/o Genentech, Inc.

A Member of the Roche Group

1 DNA Way

South San Francisco, CA 94080-4990

U.S. License No. 0136

Distributed by:

Genentech USA, Inc.

A Member of the Roche Group

1 DNA Way

South San Francisco, CA 94080-4990

© 2017 Genentech, Inc. All rights reserved.

Instructions for Use
PEGASYS® (PEG-ah-sis)
(peginterferon alfa-2a)
Injection
For Subcutaneous Use
Prefilled Syringe

First read the Medication Guide that comes with PEGASYS for the most important information you need to know about PEGASYS. Be sure that you read, understand and follow these Instructions for Use before injecting PEGASYS. Your healthcare provider should show you how to prepare, measure and inject PEGASYS properly before you use it for the first time. Ask your healthcare provider if you have any questions.

PEGASYS prefilled syringes come in a Monthly Convenience Pack that contains 4 prefilled syringes of PEGASYS in a box with 4 needles and 4 alcohol pads, or without alcohol pads. Each needle has a needle-stick protection device.

Before starting, collect all of the supplies that you will need to use for preparing and injecting PEGASYS. You will need the following supplies:

- 1 single-dose disposable prefilled syringe of PEGASYS
- 1 needle with needle-stick protection device
- 1 alcohol pad
- You will also need a puncture-resistant disposable container to throw away used prefilled syringes and needles as soon as you finish your injection. See “How should I dispose of used syringes and needles?”

Important:

- Never reuse disposable prefilled syringes and needles.
- Throw away the prefilled syringe of PEGASYS after you use it 1 time, even if there is any medicine left in it.
- **Do not** shake PEGASYS. If shaken, PEGASYS may not work properly.

How should I prepare a dose of PEGASYS?

1. Find a well-lit, clean, flat surface such as a table.
2. Take a carton containing PEGASYS out of the refrigerator. Check the date on the carton the PEGASYS comes in. Make sure the expiration date has not passed. Do not use if the expiration date has passed (see Figure A).

Figure A:

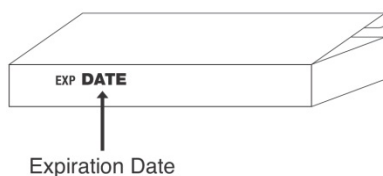

3. Remove the prefilled syringe of PEGASYS from the carton. Look at the prefilled syringe of PEGASYS. The solution should be clear and colorless to slightly yellowish, without particles (see Figure B). If there is foam in the solution, put it back in the refrigerator for use at a later time and use another syringe.

Figure B:

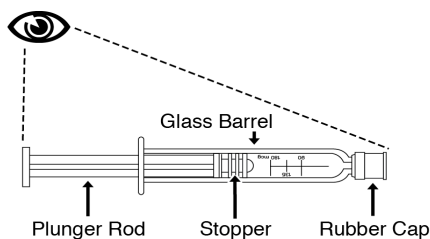

Do not use the prefilled syringe of PEGASYS if:

- the medicine remains cloudy after a few minutes at room temperature
- has particles
- the medicine is not colorless to slightly yellowish
- the expiration date has passed (see Figure C).

Figure C:

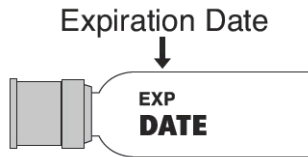

4. Wash your hands well with soap and warm water. Keep your work area, your hands, and injection site clean to decrease the risk of infection.
5. Lay the syringe on a flat clean surface and wait a few minutes until it reaches room temperature. If you notice condensation water on the outside of the syringe, wait another few minutes until it disappears.

How do I attach the needle to the PEGASYS prefilled syringe?

6. Remove the needle from its package. **Do not** remove the needle shield yet. Keep the needle covered until just before you give the injection (see Figure D).

Figure D:

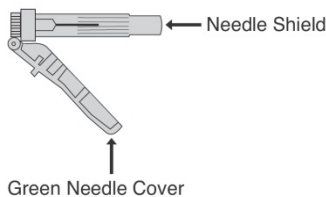

7. Remove and throw away the rubber cap from the tip of the syringe barrel (see Figure E).

Figure E:

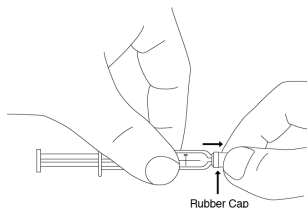

8. With one hand, hold the syringe by the barrel. With your other hand, hold the needle close to the hub where the green needle cover connects to the syringe (see Figure F).

Figure F:

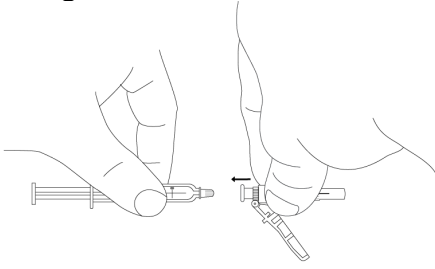

9. Push the needle onto the syringe and tighten by using an easy twisting motion in the direction of the arrow (see Figure G).

Figure G:

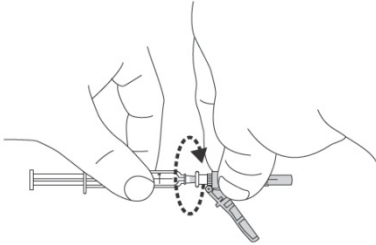

Here is a picture of what the syringe will look like after you finish attaching the needle (see Figure H).

Figure H:

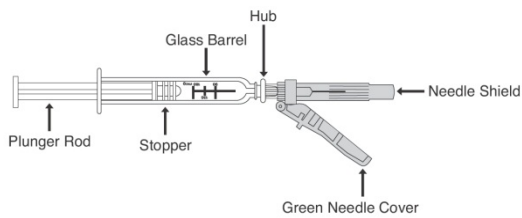

10. Lay the syringe and needle down on your clean work surface. Be sure that the plastic needle shield covers the needle. Never let the needle touch any surface.

How should I choose a site for injection?

11. You can inject PEGASYS under the skin on your stomach or thigh (see Figure I). Avoid your navel and waistline. You should use a different place each time you give yourself an injection.

Figure I:

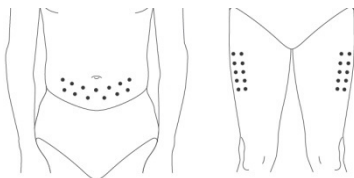

12. Clean the area using the alcohol pad. Let the skin air dry.

How do I prepare the PEGASYS prefilled syringe for injection?

13. Pull the green needle cover back from the needle toward the syringe barrel. The green needle cover will stay in the position you set. Do not remove it. This is the needle-stick protection device (see Figure J).

Figure J:

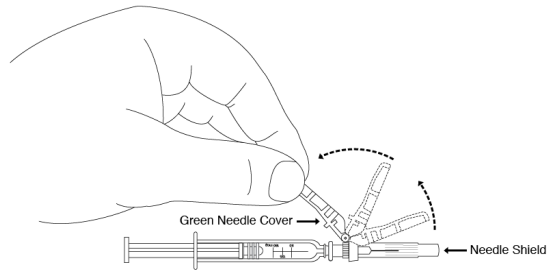

14. Hold the syringe and needle tightly at the hub. Gently rock the plastic needle shield back and forth to prepare for removal. Remove the plastic needle shield by pulling it straight off (see Figure K).

Figure K:

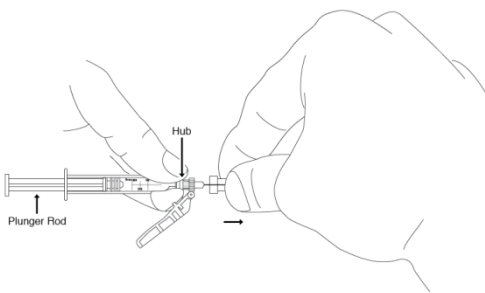

15. Remove air bubbles from the syringe.

- Hold the syringe with the needle pointing up to the ceiling.
- Using your thumb and finger, gently tap the syringe to bring air bubbles to the top (see Figure L).
- Press the plunger in slightly to push air bubbles out of the syringe.

Figure L:



16. Depending on the dose of PEGASYS that your healthcare provider prescribes, you may have to get rid of (discard) some of the medicine from the prefilled syringe before you inject the medicine. The syringe has markings for 180 mcg, 135 mcg, and 90 mcg. Your healthcare provider will tell you which mark to use (see Figure M and Figure N).

Figure M:

Figure N:

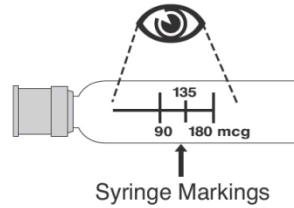
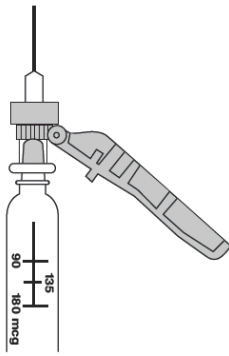

Do not decrease or increase your dose of PEGASYS unless your healthcare provider tells you to.

How do I give the injection of PEGASYS?

17. Position the point of the needle (the bevel) so it is facing up (see Figure O).

Figure O:

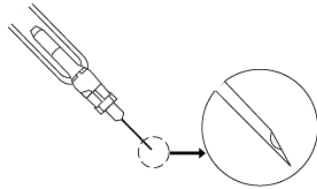

18. Pinch a fold of skin on your stomach or thigh firmly with your thumb and forefinger (see Figure P).

Figure P:



19. Hold the syringe like a pencil at a 45° to 90° angle to your skin. With a quick “dart-like” motion, push the needle into the skin as far as it will go (see Figure Q).

Figure Q:



20. After the needle is inserted, remove the hand used to pinch the skin and use it to hold the syringe barrel.

- Pull the plunger of the syringe back slightly.
- **If blood comes into the syringe**, the needle has entered a blood vessel.
 - Do not inject PEGASYS. Withdraw the needle and throw away the syringe and needle in the puncture-resistant container. See **“How should I dispose of used syringes and needles?”**
 - Then, repeat steps 1 through 16 with a new prefilled syringe and prepare a new injection site.

- **If no blood is present in the syringe**, inject the medicine by gently pressing the plunger all the way down the syringe barrel, until the syringe is empty.
21. When the syringe is empty, pull the needle out of the skin. Wipe the area with an alcohol pad.
22. To prevent needle-stick injuries, before you dispose of the syringe and needle, push the green needle cover toward the needle (see Figure R). Then place the free end of the green cap on a flat surface and push down with a firm and quick motion until it clicks and covers over the needle (see Figure S).

Figure R:

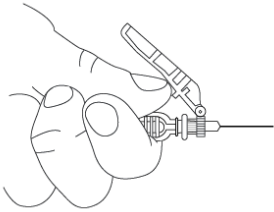
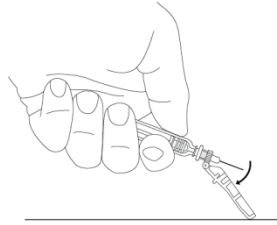

Figure S:



23. Throw away the used syringe and needle right away as described below. See **“How should I dispose of used syringes and needles?”**

How should I dispose of used syringes and needles?

- Put your used needles and syringes in a FDA-cleared sharps disposal container right away after use. **Do not throw away (dispose of) loose needles and syringes in your household trash.**
- If you do not have a FDA-cleared sharps disposal container, you may use a household container that is:
 - made of a heavy-duty plastic,
 - can be closed with a tight-fitting, puncture-resistant lid, without sharps being able to come out,
 - upright and stable during use,
 - leak-resistant, and
 - properly labeled to warn of hazardous waste inside the container.
- When your sharps disposal container is almost full, you will need to follow your community guidelines for the right way to dispose of your sharps disposal container. There may be state or local laws about how you should throw away used needles and syringes. For more information about safe sharps disposal, and for specific information about sharps disposal in the state that you live in, go to the FDA’s website at: <http://www.fda.gov/safesharpsdisposal> .
- Do not dispose of your used sharps disposal container in your household trash unless your community guidelines permit this. Do not recycle your used sharps disposal container.

Always keep the puncture-resistant container out of the reach of children.

How should I store PEGASYS?

- Store PEGASYS prefilled syringes in a refrigerator at 36°F to 46°F (2°C to 8°C).
- **Do not** leave PEGASYS out of the refrigerator for more than 24 hours.
- **Do not** freeze or shake PEGASYS.
- Protect PEGASYS from light.

This Instructions for Use has been approved by the U.S. Food and Drug Administration.

Revised: October 2017

PEGASYS® is a registered trademark of Hoffmann-La Roche Inc.

Manufactured by:

Hoffmann-La Roche, Inc.

c/o Genentech, Inc.

A Member of the Roche Group

1 DNA Way

South San Francisco, CA 94080-4990

U.S. License No. 0136

Distributed by:

Genentech USA, Inc.

A Member of the Roche Group

1 DNA Way

South San Francisco, CA 94080-4990

© 2017 Genentech, Inc. All rights reserved.

Instructions for Use
PEGASYS® (PEG-ah-sis)
(peginterferon alfa-2a)
Injection
for Subcutaneous Use
Vial

First read the Medication Guide that comes with PEGASYS for the most important information you need to know about PEGASYS. Be sure that you read, understand and follow these Instructions for Use before injecting PEGASYS. Your healthcare provider should show you how to prepare, measure, and inject PEGASYS properly before you use it for the first time. Ask your healthcare provider if you have any questions. Before starting, collect all of the supplies that you will need to use for preparing and injecting PEGASYS. You will need the following supplies:

- 1 vial of PEGASYS
- 1 single-use disposable syringe and needle
- several alcohol pads
- You will also need a puncture-resistant disposable container to throw away used syringes, needles, and vials as soon as you finish your injection. See **“How should I dispose of used syringes, needles, and vials?”**

Follow your healthcare provider’s instructions for the type of syringe and needle to use to prepare and inject your dose. If you will be injecting a child with PEGASYS, you will need a special syringe called a tuberculin syringe, which can measure doses of PEGASYS that are 1 milliliter (1mL) or less. When you get your prescription from the pharmacy, ask your pharmacist for the syringe and needle that you need to prepare and inject a dose of PEGASYS from the single-dose vial.

Important:

- Never reuse disposable syringes and needles.
- Throw away the vial of PEGASYS after you use it 1 time even if there is medicine left in the vial.
- Do not shake PEGASYS. If shaken, PEGASYS may not work properly.

How should I prepare a dose of PEGASYS?

1. Find a well-lit, clean, flat working surface such as a table.
2. Take a carton containing PEGASYS out of the refrigerator. Check the date on the carton the PEGASYS comes in. Make sure the expiration date has not passed. Do not use if the expiration date has passed (see Figure A).

Figure A:

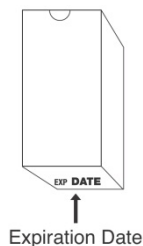

3. Wash your hands well with soap and warm water. Keep your work area, your hands, and injection site clean to decrease the risk of infection.
4. Remove the vial of PEGASYS from the carton. Look at the vial of PEGASYS. The solution should be clear and colorless to slightly yellowish, without particles (see Figure B).

Figure B:

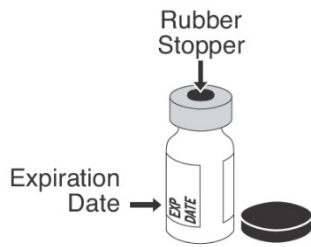

Do not use the vial of PEGASYS if:

- the medicine is cloudy
- has particles
- the medicine is not colorless to slightly yellowish
- the expiration date has passed (see Figure B)

5. Warm the refrigerated medicine by gently rolling it in the palms of your hands for about one minute. Do not shake PEGASYS.
6. Remove (flip off) the plastic cap from the top of the PEGASYS vial (see Figure C). Clean the rubber stopper on the top of the vial with an alcohol pad (see Figure D).

Figure C:



Figure D:



If you are not sure how much medicine to use or which mark on the syringe to use, stop and call your healthcare provider right away.

7. Open the package for the syringe you are using and if it does not have a needle attached, then attach a new needle to the syringe.
8. Remove the protective cap from the needle on the syringe. Never let the needle touch any surface. Fill the syringe with air by pulling back on the plunger to the mark on the syringe barrel that matches the dose prescribed by your healthcare provider (see Figure E).

Figure E:

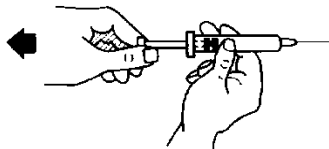

9. Hold the vial of PEGASYS on your flat surface. Do not touch the cleaned rubber stopper.
10. Push the needle straight down through the middle of the rubber stopper on the vial. Slowly inject all the air from the syringe into the air space above the solution. Do not inject air into the fluid (see Figure F).

Figure F:

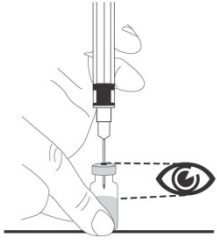

11. Keep the needle in the vial. Turn the vial upside down.
Make sure the tip of the needle is in the PEGASYS solution.
Slowly pull the plunger back to fill the syringe with PEGASYS solution to the dose (mL or cc markings on the syringe) that matches the dose prescribed by your healthcare provider (see Figure G).

Figure G:



12. Do not remove the needle from the vial. Lay the vial and syringe on its side on your flat work surface until you are ready to inject the PEGASYS solution (see Figure H).

Figure H:

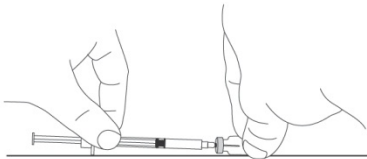

How should I choose a site for injection?

13. You can inject PEGASYS under the skin on your stomach or thigh (see Figure I). Avoid your navel and waistline. You should use a different place each time you give yourself an injection.

Figure I:

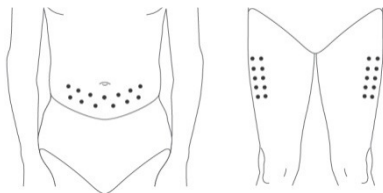

14. Clean the area using an alcohol pad and let the skin air dry.

How should I give an injection?

15. Pick up the vial and syringe from your flat work surface. Remove the syringe and needle from the vial.
 - Hold the syringe in the hand that you will use to inject PEGASYS.
 - Do not touch the needle or allow it to touch the work surface.
16. Remove air bubbles from the syringe.
 - Hold the syringe with the needle pointing up to the ceiling.
 - Using your thumb and finger, tap the syringe to bring air bubbles to the top (see Figure J).
 - Press the plunger in slightly to push air bubbles out of the syringe.

Figure J:



17. Position the point of the needle (the bevel) so it is facing up (see Figure K).

Figure K:

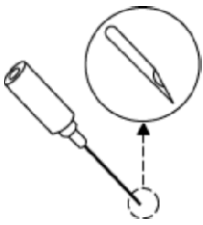

18. Pinch a fold of skin on your stomach or thigh firmly between your thumb and forefinger (see Figure L).

Figure L:



19. Hold the syringe like a pencil at a 45° to 90° angle to your skin. With a quick “dart-like” motion, push the needle into the skin as far as it will go (see Figure M).

Figure M:



20. After the needle is inserted, remove the hand used to pinch the skin and use it to hold the syringe barrel.

- Pull the plunger of the syringe back slightly.
- **If blood comes into the syringe**, the needle has entered a blood vessel.
 - Do not inject PEGASYS. Withdraw the needle and throw away the syringe, needle, and vial in the puncture-resistant container. See “**How should I dispose of used syringes, needles, and vials?**”
 - Then, repeat steps 1 through 19 with a new vial of PEGASYS and inject the medicine at a new injection site.
- **If no blood is present in the syringe**, inject the medicine by gently pressing the plunger all the way down the syringe barrel, until the syringe is empty.

21. When the syringe is empty, pull the needle out of the skin. Wipe the area with an alcohol pad.
22. Throw away the used syringe, needle, and vial. See “**How should I dispose of used syringes, needles, and vials?**”

How should I dispose of used syringes, needles, and vials?

- Put your used needles and syringes in a FDA-cleared sharps disposal container right away after use. **Do not throw away (dispose of) loose needles and syringes in your household trash.**
- If you do not have a FDA-cleared sharps disposal container, you may use a household container that is:
 - made of a heavy-duty plastic,
 - can be closed with a tight-fitting, puncture-resistant lid, without sharps being able to come out,
 - upright and stable during use,
 - leak-resistant, and
 - properly labeled to warn of hazardous waste inside the container.
- When your sharps disposal container is almost full, you will need to follow your community guidelines for the right way to dispose of your sharps disposal container. There may be state or local laws about how you should throw away used needles and syringes. For more information about safe sharps disposal, and for specific information about sharps disposal in the state that you live in, go to the FDA’s website at: <http://www.fda.gov/safesharpsdisposal> .
- Do not dispose of your used sharps disposal container in your household trash unless your community guidelines permit this. Do not recycle your used sharps disposal container.

How should I store PEGASYS?

- Store PEGASYS single-dose vials in a refrigerator at 36°F to 46°F (2°C to 8°C).
- **Do not** leave PEGASYS out of the refrigerator for more than 24 hours.
- **Do not** freeze or shake PEGASYS.
- Protect PEGASYS from light.

This Instructions for Use has been approved by the U.S. Food and Drug Administration.

Revised: October 2017

PEGASYS® is a registered trademark of Hoffmann-La Roche Inc.

Manufactured by:

Hoffmann-La Roche, Inc.

c/o Genentech, Inc.

A Member of the Roche Group

1 DNA Way

South San Francisco, CA 94080-4990

U.S. License No. 0136

Distributed by:

Genentech USA, Inc.

A Member of the Roche Group

1 DNA Way

South San Francisco, CA 94080-4990

© 2017 Genentech, Inc. All rights reserved.